

DETAIL DESCRIPTION:
WALL LAYOUT

DETAIL NUMBER:
--

DATE:
4/21/20

SCALE:
NTS

DRAWN BY:

**deltec
homes**



DELTEC HOMES, INC. IS THE AUTHOR OF THIS PLAN. THESE PLANS AND SPECIFICATIONS ARE THE SOLE AND EXCLUSIVE PROPERTY OF DELTEC HOMES, INC. ANY FEES PAID BY THE CLIENT OR OWNER TO DELTEC PROVIDES A LICENSE FOR THE LIMITED USE OF THESE PLANS. THESE PLANS ARE PRINTED FOR REFERENCE PURPOSES ONLY TO ASSIST DURING THE PURCHASE AND DELIVERY OF A PANELIZED WALLING UNIT FROM DELTEC HOMES, INC. DELTEC HOMES, INC. MAKES NO REPRESENTATION OR WARRANTY AS TO THE SUFFICIENCY OF THESE PLANS IN ANY RESPECT AND THE USER IS ADVISED THAT THESE PLANS HAVE NOT BEEN APPROVED BY ANY SPECIFIC REGIONAL, STATE OR LOCAL BUILDING DEPARTMENT. DELTEC HOMES, INC. IS NOT RESPONSIBLE FOR ANY VIOLATIONS OF ANY APPLICABLE BUILDING CODES OR REGULATIONS. THE REPRODUCTION OF THESE PLANS AND SPECIFICATIONS AND/OR USE IN WHOLE OR PART EXCEPT FOR THE PURPOSE FOR WHICH LICENSED IS EXPRESSLY PROHIBITED. RETURN OF THESE PLANS AND ANY REPRODUCTIONS SHALL BE MADE UPON REQUEST. COPYRIGHT © DELTEC HOMES, INC. 2010

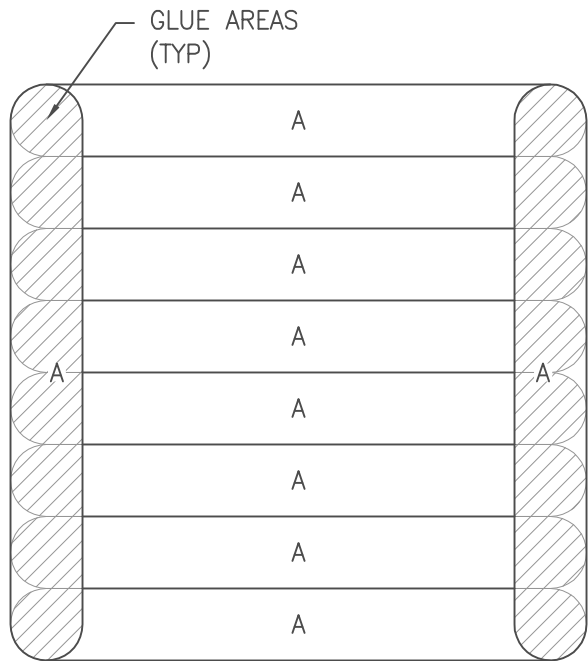

FRONT
(EXTERIOR)

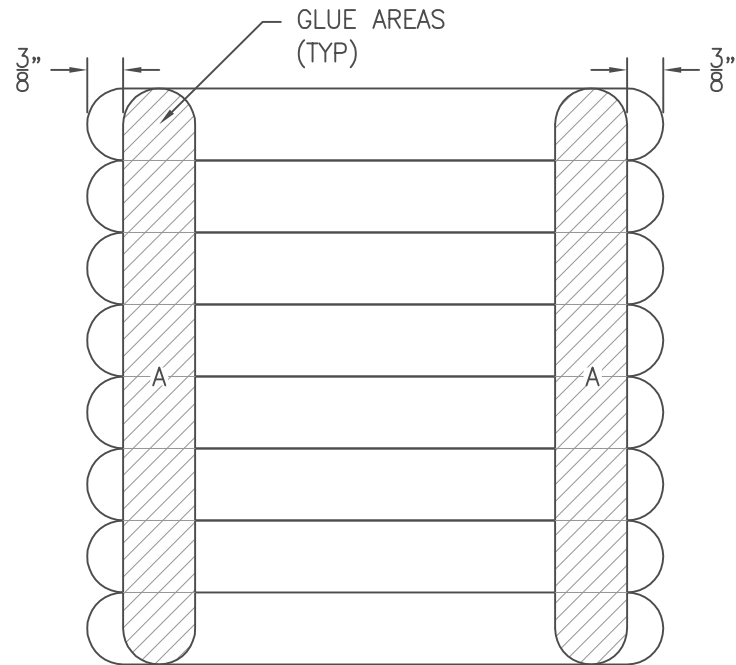

BACK
(INTERIOR)

NOTE: INSTALL VERTICAL
PIECES FLUSH TO BOTTOM OF WALL

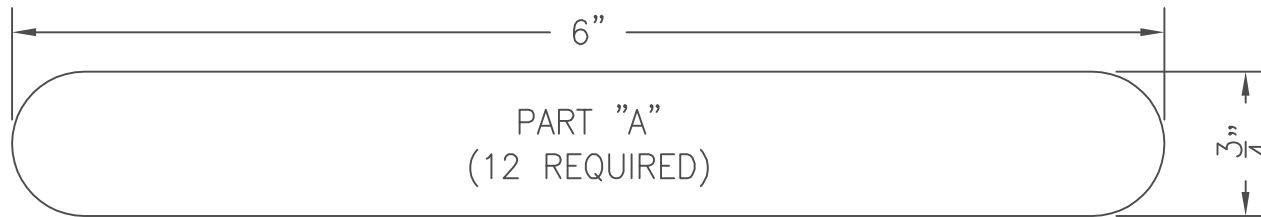

DETAIL DESCRIPTION:
SOLID WALL PANEL (3 REQUIRED)

DETAIL NUMBER:
--

DATE:
4/22/20

SCALE:
6" = 1'-0"

DRAWN BY:

**deltec
homes**



DELTEC HOMES, INC. IS THE AUTHOR OF THIS PLAN. THESE PLANS AND SPECIFICATIONS ARE THE SOLE AND EXCLUSIVE PROPERTY OF DELTEC HOMES, INC. ANY FEES PAID BY THE CLIENT OR OWNER TO DELTEC PROVIDES A LICENSE FOR THE LIMITED USE OF THESE PLANS. THESE PLANS ARE PRINTED FOR REFERENCE PURPOSES ONLY TO ASSIST DURING THE PURCHASE AND DELIVERY OF A PANELIZED WALLING UNIT FROM DELTEC HOMES, INC. DELTEC HOMES, INC. MAKES NO REPRESENTATION OR WARRANTY AS TO THE ACCURACY OR SUFFICIENCY OF THESE PLANS IN ANY RESPECT AND THE USER IS ADVISED THAT THESE PLANS HAVE NOT BEEN APPROVED BY ANY SPECIFIC REGIONAL, STATE, COUNTY, OR LOCAL BUILDING DEPARTMENT. DELTEC HOMES, INC. AND ITS PROFESSIONALS SHALL BE RETAINED FOR THE PURPOSE OF DESIGNING BUILDING SITE ELEMENTS, FOUNDATIONS, P.A. AND E SYSTEMS AS REQUIRED. THE REPRODUCTION OF THESE PLANS AND SPECIFICATIONS AND/OR USE IN WHOLE OR PART EXCEPT FOR THE PURPOSE FOR WHICH LICENSED IS EXPRESSLY PROHIBITED. RETURN OF THESE PLANS AND ANY REPRODUCTIONS SHALL BE MADE UPON REQUEST. COPYRIGHT © DELTEC HOMES, INC. 2010

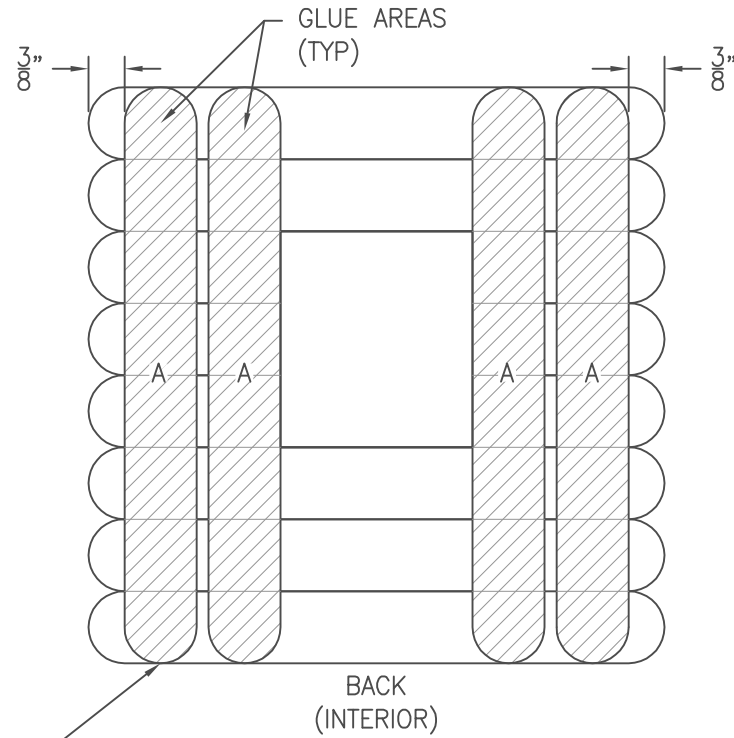
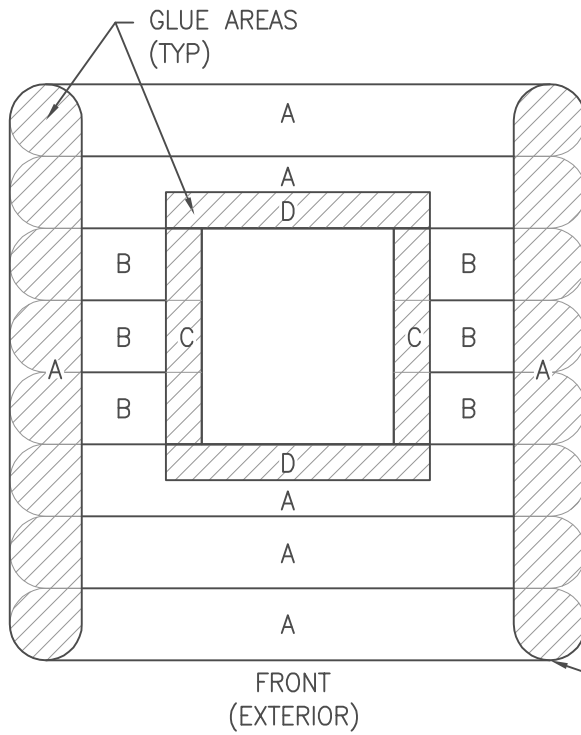

NOTE: INSTALL VERTICAL
PIECES FLUSH TO BOTTOM OF WALL

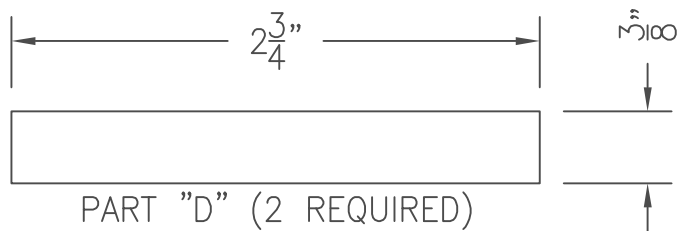
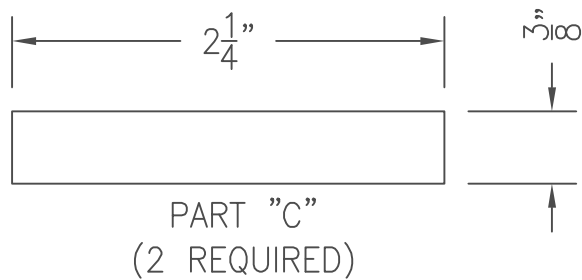
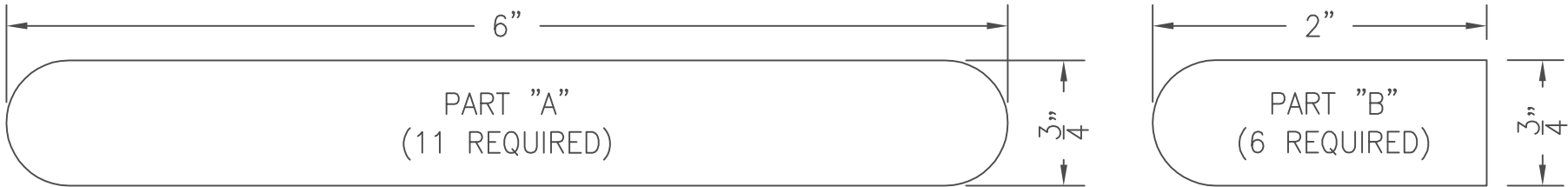

DETAIL DESCRIPTION:
WALL PANEL WITH WINDOW (4 REQUIRED)

DETAIL NUMBER:
--

DATE:
4/22/20

SCALE:
6" = 1'-0"

DRAWN BY:

**deltec
homes**



DELTEC HOMES, INC. IS THE AUTHOR OF THIS PLAN. THESE PLANS AND SPECIFICATIONS ARE THE SOLE AND EXCLUSIVE PROPERTY OF DELTEC HOMES, INC. ANY FEES PAID BY THE CLIENT OR OWNER TO DELTEC PROVIDES A LICENSE FOR THE LIMITED USE OF THESE PLANS. THESE PLANS ARE PRINTED FOR REFERENCE PURPOSES ONLY TO ASSIST DURING THE PURCHASE AND DELIVERY OF A PANELIZED BUILDING UNIT FROM DELTEC HOMES, INC. DELTEC HOMES, INC. MAKES NO REPRESENTATION OR WARRANTY AS TO THE ACCURACY OF THESE PLANS IN ANY RESPECT AND THE USER IS ADVISED THAT THESE PLANS HAVE NOT BEEN APPROVED BY ANY SPECIFIC REGIONAL, STATE, COUNTY, OR LOCAL PROFESSIONAL ENGINEER, ARCHITECT, OR OTHER PROFESSIONAL. THE REPRODUCTION OF THESE PLANS AND SPECIFICATIONS AND/OR USE IN WHOLE OR PART EXCEPT FOR THE PURPOSE FOR WHICH LICENSED IS EXPRESSLY PROHIBITED. RETURN OF THESE PLANS AND ANY REPRODUCTIONS SHALL BE MADE UPON REQUEST. COPYRIGHT © DELTEC HOMES, INC. 2020

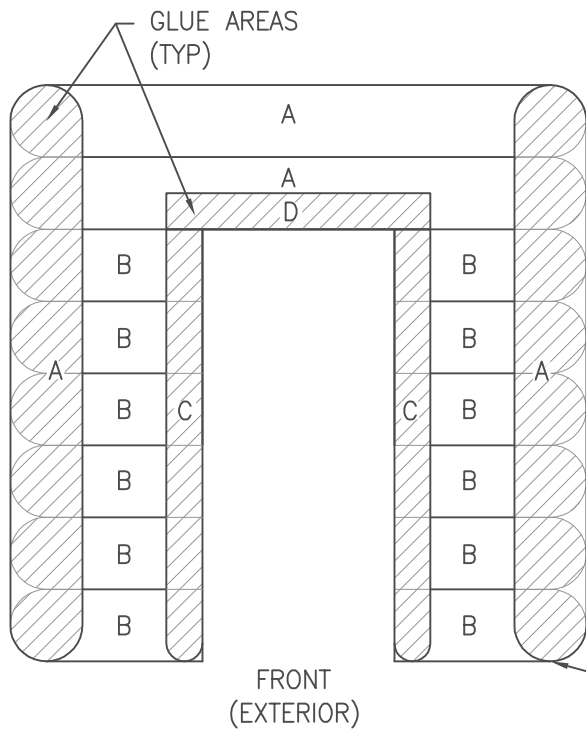

FRONT
(EXTERIOR)

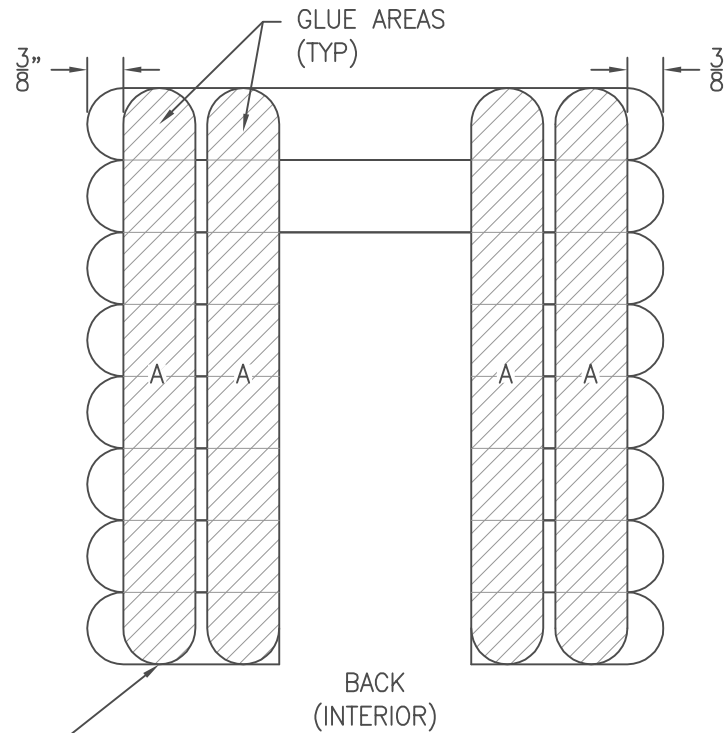

BACK
(INTERIOR)

NOTE: INSTALL VERTICAL
PIECES FLUSH TO BOTTOM OF WALL

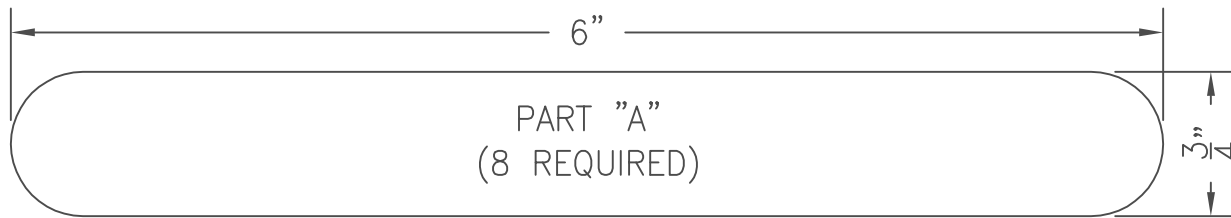

PART "A"
(8 REQUIRED)

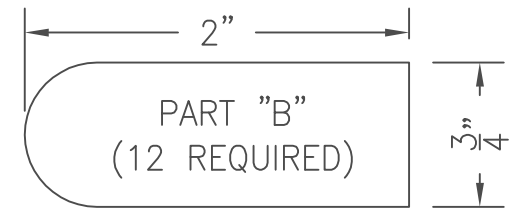

PART "B"
(12 REQUIRED)

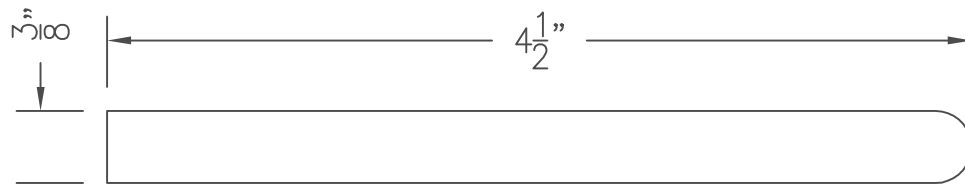

PART "C" (2 REQUIRED)

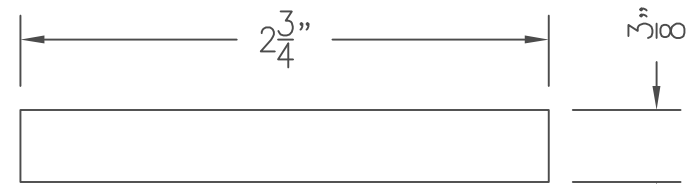

PART "D" (1 REQUIRED)

DETAIL DESCRIPTION:
WALL PANEL WITH DOOR (1 REQUIRED)

DETAIL NUMBER:
--

DATE:
4/22/20

SCALE:
6" = 1'-0"

DRAWN BY:

**deltec
homes**



DELTEC HOMES, INC. IS THE AUTHOR OF THIS PLAN AND SPECIFICATIONS ARE THE SOLE AND EXCLUSIVE PROPERTY OF DELTEC HOMES, INC. ANY FEES PAID BY THE CLIENT OR OWNER TO DELTEC PROVIDES A LICENSE FOR THE LIMITED USE OF THESE PLANS. THESE PLANS ARE PRINTED FOR REFERENCE PURPOSES ONLY TO ASSIST DURING THE PURCHASE AND DESIGN OF A PANELIZED HOUSING UNIT FROM DELTEC HOMES, INC. DELTEC HOMES, INC. MAKES NO REPRESENTATION OR WARRANTY AS TO THE ACCURACY OR COMPLETENESS OF THESE PLANS IN ANY RESPECT AND THE USER IS ADVISED THAT THESE PLANS HAVE NOT BEEN APPROVED BY ANY SPECIFIC REGIONAL, BUILDING, OR LOCAL AUTHORITY. DELTEC HOMES, INC. AND DELTEC HOMES, INC. DESIGN, FOUNDATIONS, P.A. AND E SYSTEMS AS REQUIRED. THE REPRODUCTION OF THESE PLANS AND SPECIFICATIONS AND/OR USE IN WHOLE OR PART EXCEPT FOR THE PURPOSE FOR WHICH LICENSED IS EXPRESSLY PROHIBITED. RETURN OF THESE PLANS AND ANY REPRODUCTIONS SHALL BE MADE UPON REQUEST. COPYRIGHT DELTEC HOMES, INC. 2020

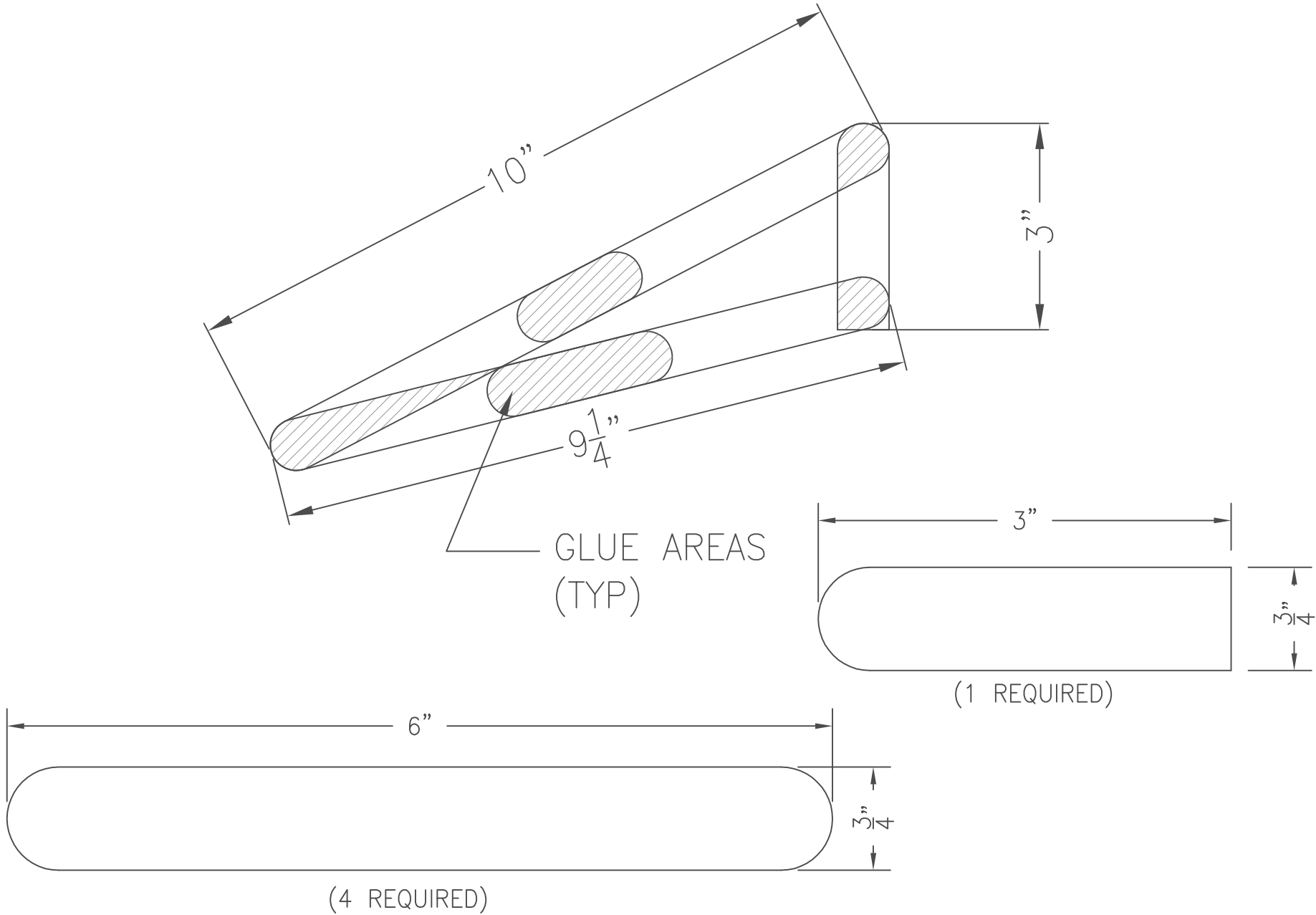

DETAIL DESCRIPTION:
ROOF TRUSS (8 REQUIRED)

DETAIL NUMBER:
--

DATE:
4/22/20

SCALE:
6" = 1'-0"

DRAWN BY:
IO

**deltec
homes**



DELTEC HOMES, INC. IS THE AUTHOR OF THIS PLAN. THESE PLANS AND SPECIFICATIONS ARE THE SOLE AND EXCLUSIVE PROPERTY OF DELTEC HOMES, INC. ANY FEES PAID BY THE CLIENT OR OWNER TO DELTEC PROVIDES A LICENSE FOR THE LIMITED USE OF THESE PLANS. THESE PLANS ARE PRINTED FOR REFERENCE PURPOSES ONLY TO ASSIST DURING THE PURCHASE AND DELIVERY OF A PANELIZED TRUSSING UNIT FROM DELTEC HOMES, INC. DELTEC HOMES, INC. MAKES NO REPRESENTATION OR WARRANTY AS TO THE ACCURACY OF THESE PLANS IN ANY RESPECT AND THE USER IS ADVISED THAT THESE PLANS HAVE NOT BEEN APPROVED BY ANY SPECIFIC REGIONAL BUILDING DEPARTMENT. ANY REVISIONS TO THESE PLANS SHALL BE MADE BY DELTEC HOMES, INC. PROFESSIONALS SHOULD BE RETAINED FOR THE PURPOSE OF DESIGNING BUILDING SITE ELEMENTS, FOUNDATIONS, P.A. AND E SYSTEMS AS REQUIRED. THE REPRODUCTION OF THESE PLANS AND SPECIFICATIONS AND/OR USE IN WHOLE OR PART EXCEPT FOR THE PURPOSE FOR WHICH LICENSED IS EXPRESSLY PROHIBITED. RETURN OF THESE PLANS AND ANY REPRODUCTIONS SHALL BE MADE UPON REQUEST. COPYRIGHTED MATERIAL. DELTEC HOMES, INC. 2010

LAYOUT TEMPLATE

- MAKE SURE TO PRINT THIS PAGE "ACTUAL SIZE" NOT "FIT TO PAGE"
- LAY TRUSS PIECES ON TOP OF THE OUTLINE BELOW, AND GLUE THEM TOGETHER.
- ALIGN TWO WALLS TO THE TWO 6" LINES BELOW, AND GLUE THEM TOGETHER IN ORDER TO GET THE PROPER ANGLE.

